

SPECIFICATIONS

MECHANICAL LIFE: 40,000 make-and-break cycles.
CONTACT RATING: 0.4 VA max. @ 20 V AC or DC max.
CONTACT RESISTANCE: Below 100 m Ω typ. initial @ 2-4 V DC, 100mA.
INSULATION RESISTANCE: 500M Ω min.
DIELECTRIC STRENGTH: 500 V RMS@sea level.
OPERATING TEMPERATURE: -30°C to 85°C.

MATERIALS

HOUSING AND BASE: Glass filled nylon 66 or 4/6 flame retardant, heat stabilized (UL 94V-0)
ACTUATOR: Glass filled nylon 6/6, flame retardant, heat stabilized (UL94V-0), with standard Internal o-ring seal.
SWITCH SUPPORT: Steel, with nickel plated.
CONTACTS/TERMINALS: Silver or gold plated copper alloy

HOW TO ORDER

MODEL NO.	ACTUATOR	BUSHING	TERMINATIONS	CONTACT MATERIAL	SEAL	ROHS SOLDERING
-----------	----------	---------	--------------	------------------	------	----------------

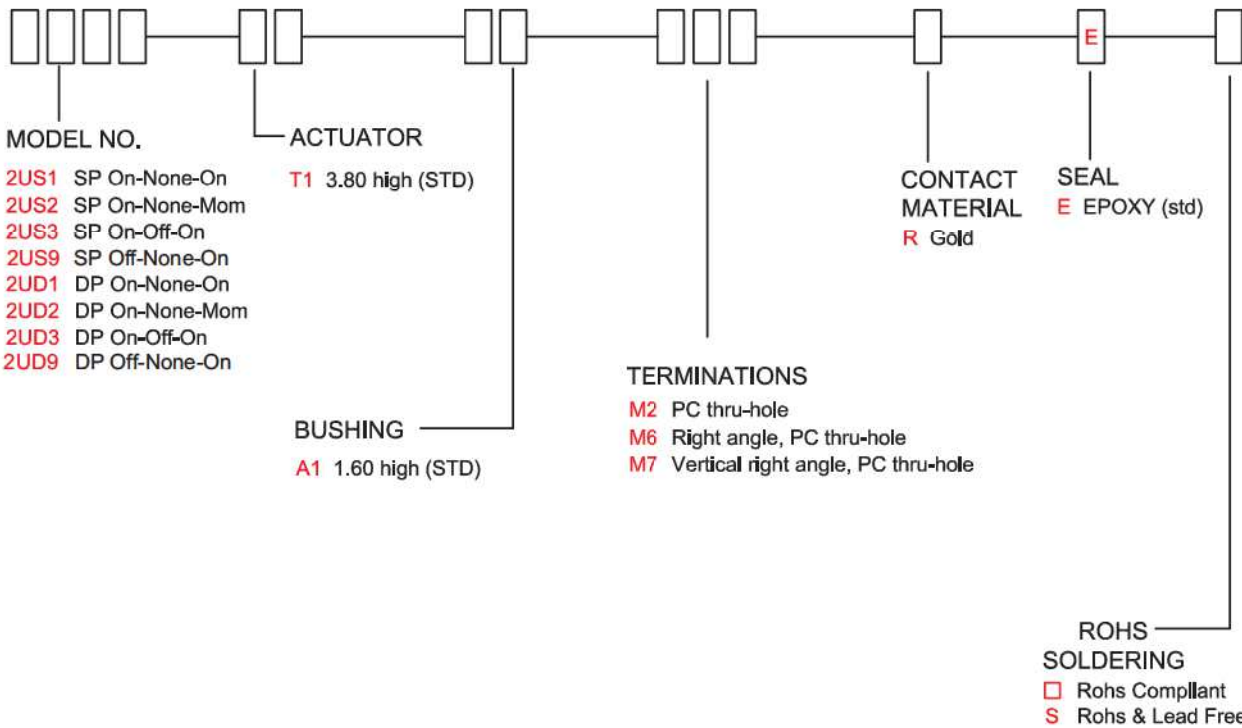

SWITCH FUNCTION

NO. POLES	MODEL NO.	SWITCH FUNCTION			CONNECTED TERMINALS / SCHEMATIC		
		POS.1	POS.2	POS.3	POS.1	POS.2	POS.3
SP	2US1	ON	NONE	ON	5-6	N/A	5-4
	2US2	MOM	NONE	ON		OPEN	
	2US3	ON	OFF	ON			
	2US9	OFF	NONE	ON	OPEN	N/A	4-6
DP	2UD1	ON	NONE	ON	2-3,5-6	N/A	2-1,5-4
	2UD2	MOM	NONE	ON		OPEN	
	2UD3	ON	OFF	ON			
	2UD9	OFF	NONE	ON	OPEN	N/A	

MOM=MOMENTARY

M2

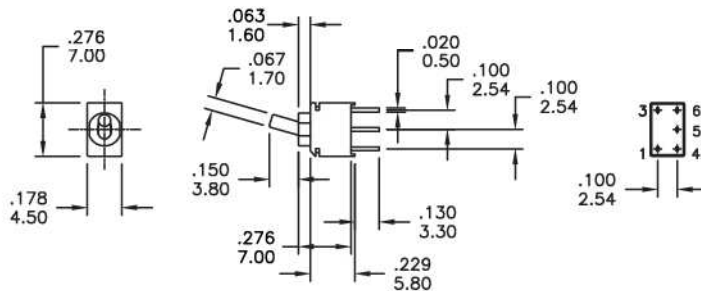

P.C. MOUNTING

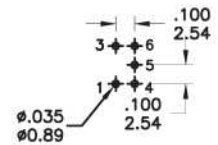

SPDT

Part No. Shown : 2US1T1A1M2RE

M2

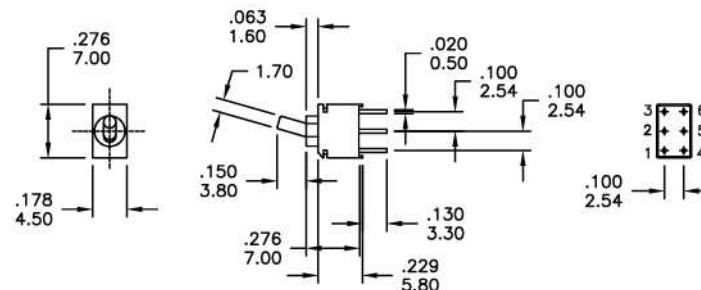

P.C. MOUNTING

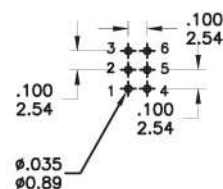

DPDT

Part No. Shown : 2UD1T1A1M2RE

M6

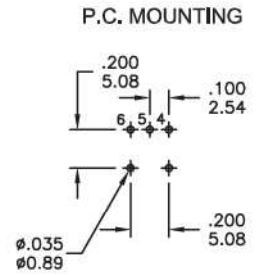
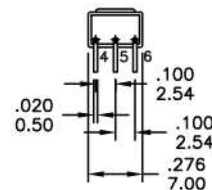
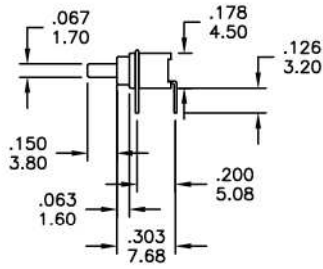
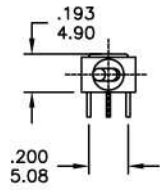

SPDT

Part No. Shown : 2US1T1A1M6RE

M6

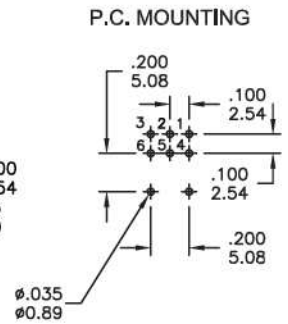
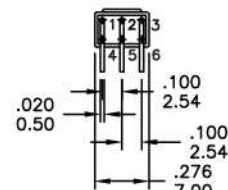
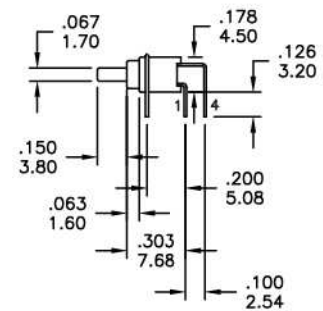
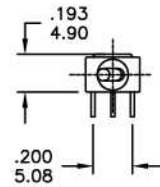

DPDT

Part No. Shown : 2UD1T1A1M6RE

M7

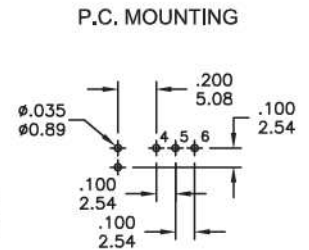
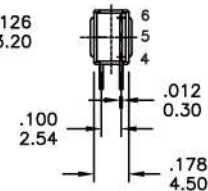
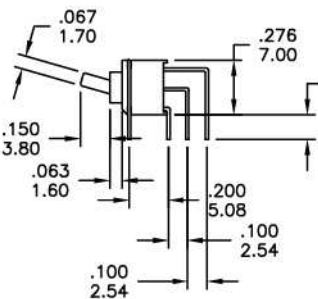
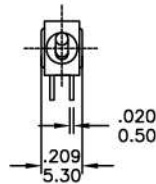
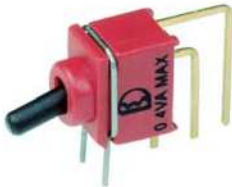

SPDT

Part No. Shown : 2US1T1A1M7RE

M7

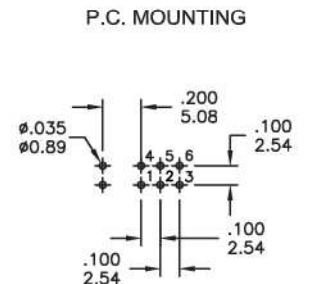
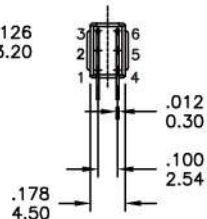
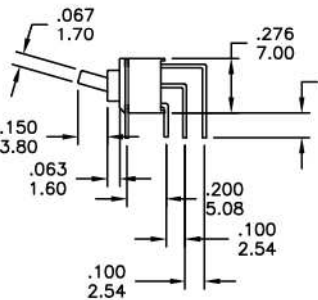
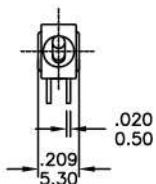

DPDT

Part No. Shown : 2UD1T1A1M7RE



IP 67
 ACCORDING TO
 EN 60529:1991+A1:2001
 IEC 60529:2001

SOLDERING PROCESSES

WAVE SOLDERING : Recommended Soldering Temperature: $260 \pm 5^\circ\text{C}$
 Duration of Solder Immersion: 5 ± 1 seconds
 (PCB is 1.6mm in thickness)

SOLDERING : Vapor phase

2U Sealed Ultraminiature Toggle Switches

Temperature Profile

Zone	Room temperature	Time (Sec)
Pre-heat (A)	150°C	Min 120s
Soak (B)	180°C~200°C	Min 150s
Peak (C)	200°C~235°C	Min 30s
Peak (D)	235°C~260°C	Min 40s
Peak (E)	260°C	Max 10s

