

APPROVAL SHEET

DESCRIPTION: PUSH BUTTON SWITCH LED

PART NO: PS004-N22NPR2KTUGXX

| | |
|--------------------------------|----------------------------------|
| CUSTOMER: <u>Martsu</u> | CUSTOMER'S PART NO: _____ |
| CUSTOMER SIGNATURE | COMMENTS |

| | | |
|-----------------|-----------------|----------------|
| APPROVAL | REVIEW | PREPARE |
| <i>Kaven</i> | <i>Tereance</i> | <i>Gina</i> |

| DIMENSION | TOLERANCE |
|--------------|-----------|
| BELOW 10 mm | ± 0.3 |
| 10~100 mm | ± 0.5 |
| ABOVE 100 mm | ± 0.8 |
| ANGLE | ± 3° |

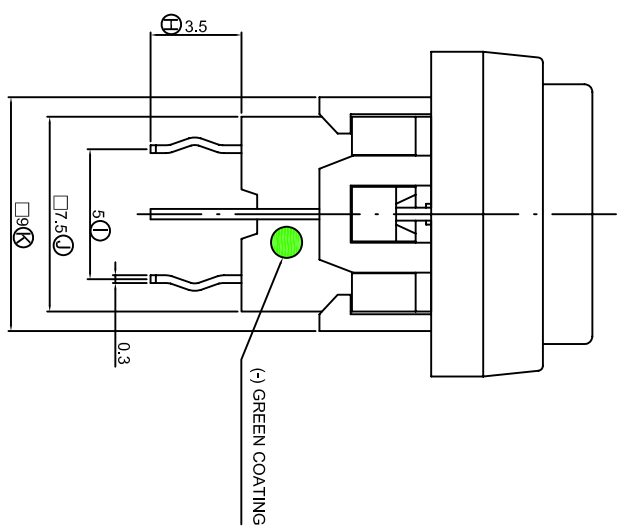
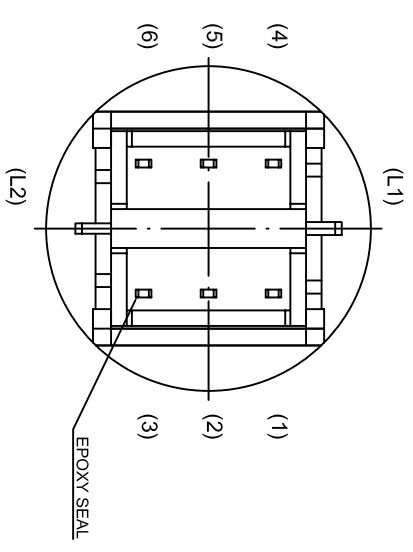
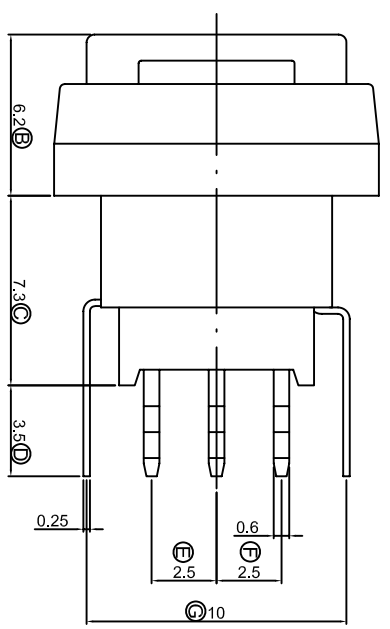
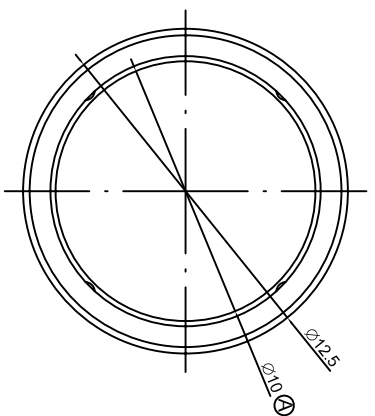

CIRCUIT DIAGRAMS

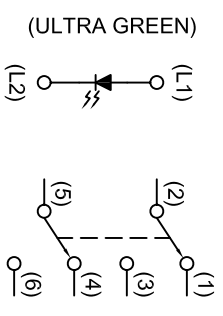

PCB LAYOUT

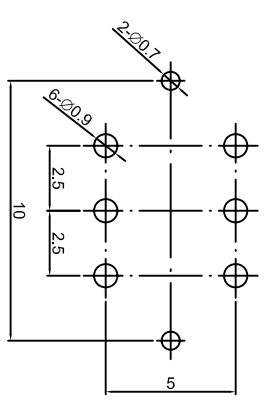

1. 2P2T , NON-LOCK TYPE .
2. RATING : 0.1A 30VDC MAX ; 0.1mA 5VDC MIN .
3. CONTACT RESISTANCE : 50 mΩ MAX .
4. INSULATION RESISTANCE : 500 V DC , 100 MΩ MIN .
5. OPERATING TEMPERATURE : -20°C ~ 70°C .
6. OPERATING FORCE : 250± 100 gf .
7. OPERATING LIFE : 50,000 CYCLES .
8. CRITICAL DIMENSIONS : 'A' ~ 'K' .

| DATE | APPROVAL | DESIGN | ENGINEERING CHANGE DESCRIPTION | DATE | APPROVAL | DESIGN | UNIT | MODE | 3D FILE NAME |
|------|----------|--------|--------------------------------|-------------|----------|--------|-------|----------------------------|---------------------|
| | | | | 2008/1/1/19 | KAVEN | ANDY | mm | PUSHBUTTON SWITCH WITH LED | |
| | | | | | CONFIRM | | 1 : 1 | PART | |
| | | | | | ALAN | | VIEW | 2D FILE NAME | PS004-N22NPR2KTUGXX |
| | | | | | | | 01 | 3D FILE NAME | |

SPECIFICATIONS OF PS004 SERIES

PUSH BUTTON SWITCH

1. POLE - POSITION : DPDT
2. OPERATING TEMPERATURE RANGE : -20°C ~ 70°C
3. RATING : 0.1A 30 VDC Max / 0.1mA 5 VDC Min .
4. ELECTRICAL PERFORMANCE

| | ITEM | TEST CONDITIONS | CRITERIA |
|-----|-----------------------|---|----------------------------|
| 4-1 | CONTACT RESISTANCE | DC 1.5V 100 mA , BY METHOD OF VOLTAGE DROP. | 50 mΩ MAX. |
| 4-2 | INSULATION RESISTANCE | DC 500V | 100 MΩ MIN. |
| 4-3 | DIELECTRIC STRENGTH | AC 500V FOR 1 MINUTE | BREAKDOWN IS NOT ALLOWABLE |

5. MECHANICAL PERFORMANCE

| | ITEM | TEST CONDITIONS | CRITERIA |
|-----|-----------------|--|------------------------------------|
| 5-1 | OPERATING FORCE | ALONG THE DIRECTION TO APPLY A STATIC LOAD AT END OF ACTUATOR. | 250±100 gf |
| 5.2 | TRAVEL | 1. FULL TRAVEL 2. CONTACT TRAVEL | 1. 1.5 ± 0.3 mm 2. 0.7 ± 0.3 mm |
| 5-3 | SOLDERABILITY | 245±5°C IN 5 SECONDS | SOLDER COVERAGE 75% MIN. |

6. SOLDERING HEAT RESISTANCE

- 6.1 MANUAL: 300±5°C IN 3 SECONDS.
- 6.2 WAVE SOLDERING: 260±5°C IN 3 SECONDS.

7. DURABILITY:

OPERATING LIFE WITH LOAD AFTER 50,000 CYCLES AT SPEED 15 ~ 20 CYCLES / MINUTE, 1.5 VDC 100 mA RESISTANCE LOAD , AFTER THAT THE SWITCH SHOULD MEET FOLLOWING SPECIFICATIONS.

7.1 CONTACT RESISTANCE : 100 m Ω MAX.

7.2 OPERATING FORCE : WITHIN THE RANGE $\pm 30\%$ OF SPECIFICATION.

7.3 INSULATION RESISTANCE : 500V DC 100 M Ω MIN.

7.4 DIELECTRIC STRENGTH : 500V AC FOR 1 MINUTE, BREAKDOWN IS NOT ALLOWABLE.

8. ENVIRONMENTAL PERFORMANCE

| | ITEM | TEST CONDITIONS | CRITERIA |
|-----|-----------|--|---|
| 8-1 | COLD | -20 $\pm 2^{\circ}\text{C}$ FOR 96 HOURS | 1. SWITCH SHOULD MEET REQUIREMENTS OF ITEM 4. 2. MECHANICAL PERFORMANCE SHOULD REMAIN TO NORMAL. |
| 8-2 | DRY HEAT | 70 $\pm 2^{\circ}\text{C}$ FOR 96 HOURS | 1. SWITCH SHOULD MEET REQUIREMENTS OF ITEM 4. 2. MECHANICAL PERFORMANCE SHOULD REMAIN TO NORMAL. |
| 8-3 | DAMP HEAT | 40 $\pm 2^{\circ}\text{C}$ 90% ~ 95% RH FOR 96 HOURS | 1. SWITCH SHOULD MEET REQUIREMENTS OF ITEM 4. 2. MECHANICAL PERFORMANCE SHOULD REMAIN TO NORMAL. |

9. LED SPECIFICATIONS

LED SPECIFICATIONS WILL BE FURNISHED DEPENDING ON DIFFERENT LED COLOR DEMAND.

SUBMINIATURE SOLID STATE LAMP

Part Number:

Mega Green

Features

- Subminiature package.
- Wide viewing angle.
- Long life-solid state reliability.
- Low package profile.
- Moisture sensitivity level : level 3.
- RoHS compliant.

Description

The Mega Green source color devices are made with Al-GaN on GaAs substrate Light Emitting Diode.

Package Dimensions

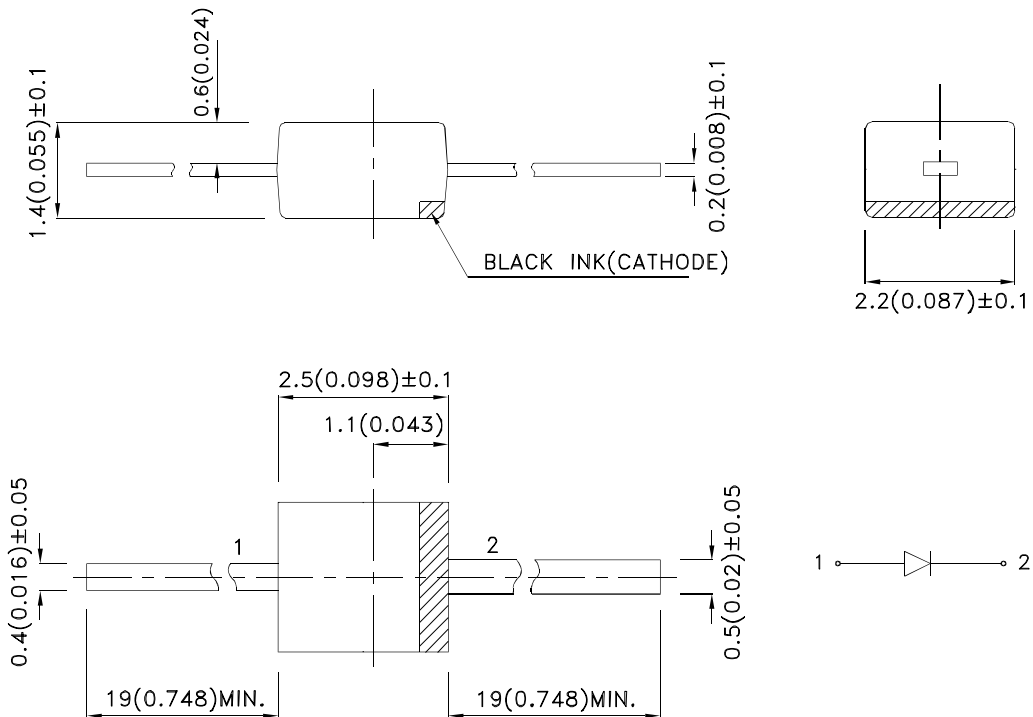

Notes:

1. All dimensions are in millimeters (inches).
2. Tolerance is $\pm 0.25(0.01)$ " unless otherwise noted.
3. Lead spacing is measured where the leads emerge from the package.
4. The specifications, characteristics and technical data described in the datasheet are subject to change without prior notice.



Selection Guide

| Part No. | Dice | Lens Type | Iv (mcd) [2] @ 20mA | | | Viewing Angle [1] |
|----------|----------------------|-------------|------------------------|------|------|----------------------|
| | | | Min. | Typ. | Max. | 2θ1/2 . |
| | Mega Green (AlGaInP) | Water Clear | 20 | 55 | 100 | 140° |

Notes:

1. θ1/2 is the angle from optical centerline where the luminous intensity is 1/2 of the optical peak value.
2. Luminous intensity/ luminous Flux: +/-15%.

Electrical / Optical Characteristics at TA=25°C

| Symbol | Parameter | Device | Min. | Typ. | Max. | Units | Test Conditions |
|--------------------|--------------------------|------------|------|------|------|-------|---------------------------|
| λ _{peak} | Peak Wavelength | Mega Green | | 574 | | nm | I _F =20mA |
| λ _D [1] | Dominant Wavelength | Mega Green | 561 | 567 | 571 | nm | I _F =20mA |
| Δλ _{1/2} | Spectral Line Half-width | Mega Green | | 20 | | nm | I _F =20mA |
| C | Capacitance | Mega Green | | 15 | | pF | V _F =0V;f=1MHz |
| V _F [2] | Forward Voltage | Mega Green | 1.6 | 2.1 | 2.5 | V | I _F =20mA |
| I _R | Reverse Current | Mega Green | | | 10 | uA | V _R = 5V |

Notes:

- 1.Wavelength: +/-1nm.
2. Forward Voltage: +/-0.1V.

Absolute Maximum Ratings at TA=25°C

| Parameter | Mega Green | Units |
|---|---------------------|-------|
| Power dissipation | 75 | mW |
| DC Forward Current | 30 | mA |
| Peak Forward Current [1] | 150 | mA |
| Reverse Voltage | 5 | V |
| Electrostatic Discharge Threshold (HBM) | 3000 | V |
| Operating/Storage Temperature | -40°C To +85°C | |
| Lead Solder Temperature [2] | 260°C For 3 Seconds | |
| Lead Solder Temperature [3] | 260°C For 5 Seconds | |

Notes:

1. 1/10 Duty Cycle, 0.1ms Pulse Width.
2. 2mm below package base.
3. 5mm below package base.

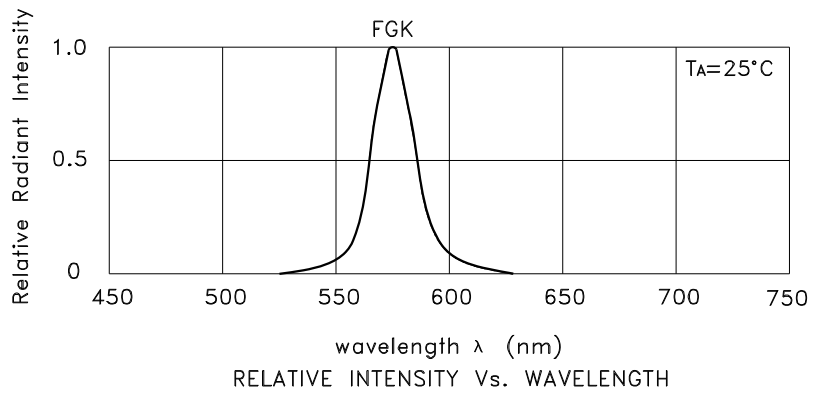

Mega Green

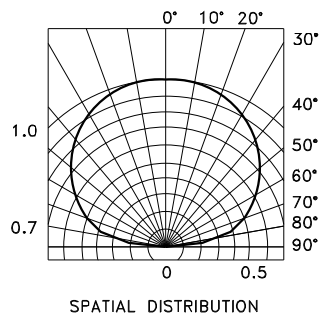
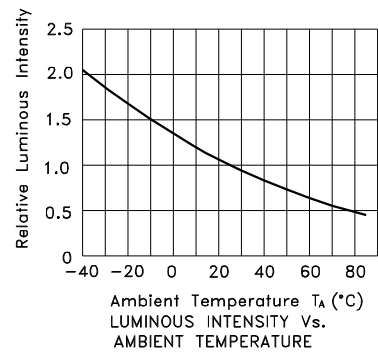
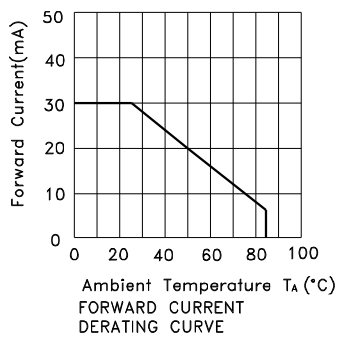
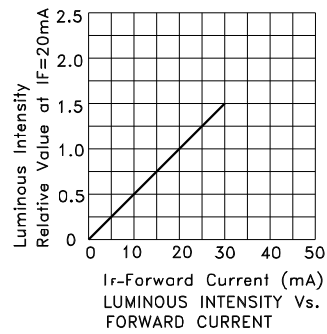
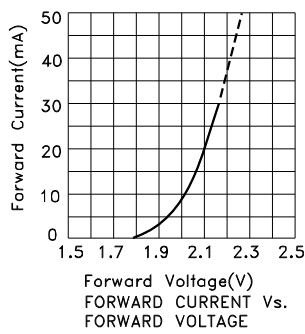

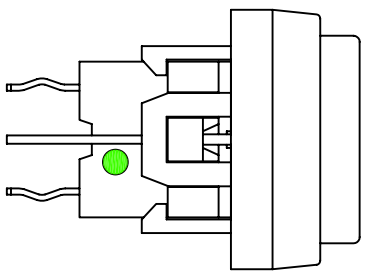
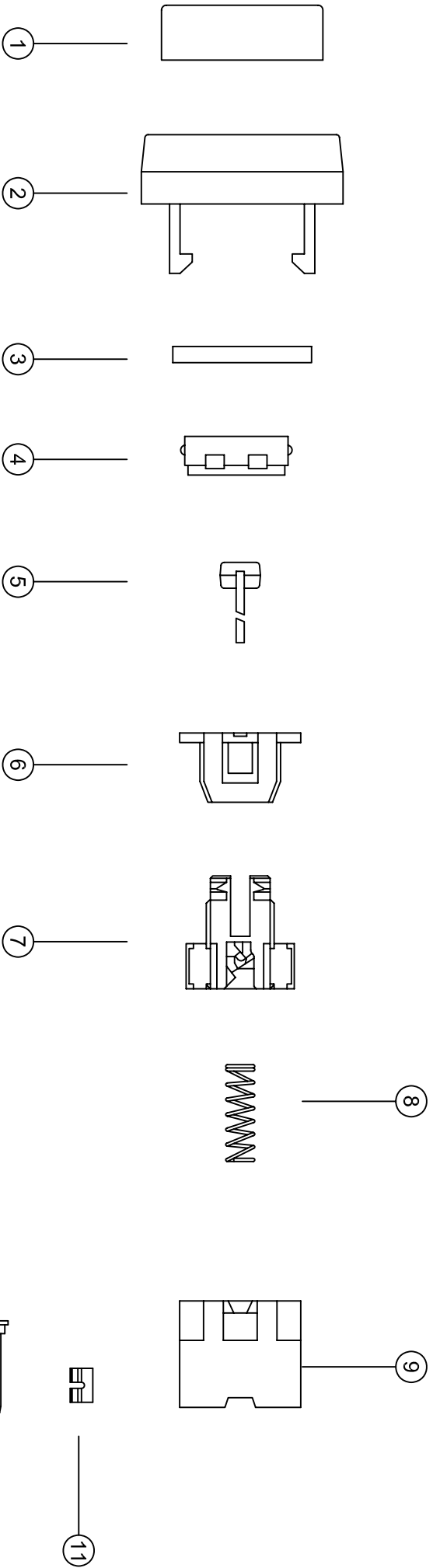

| NO. | PART NAME | QTY | MATERIAL | SPECIAL DEAL | ROHS REPORT No. |
|-----|---------------------|-----|-----------------|-------------------|---|
| 1 | LED COVER | 1 | PC-143R111 | TRANSPARENT | TWNC00277207S1 |
| 2 | KNOB FRAME | 1 | PA66+33%GF | BLACK | CE/2014/25430; CANEC1403097001 |
| 3 | FLUORESCENT PLATE | 1 | PC-143R111 | WHITE TRANSPARENT | TWNC00277207S1 |
| 4 | KNOB | 1 | PA66+33%GF | WHITE | CE/2014/25430; CANEC1311693101; CANEC1311693102 |
| 5 | LED | 1 | | ULTRA GREEN | SZHH0084529102S1; SZHH00853916 |
| 6 | COVER | 1 | PA66+33%GF | BLACK | CE/2014/25430; CANEC1403097001 |
| 7 | ACTUATOR | 1 | PA66+33%GF | WHITE | CE/2014/25430; CANEC1311693101; CANEC1311693102 |
| 8 | SPRING | 1 | STAINLESS STEEL | | F690101-LF-CTSAVYAA14-03884 |
| 9 | BASE FRAME | 1 | PA66+33%GF | BLACK | CE/2014/25430; CANEC1403097001 |
| 10 | BOARD WITH TERMINAL | 2 | PA66+33%GF | BLACK | CE/2014/25430; CANEC1403097001 |
| 11 | CLIP | 2 | PHOSPHOR BRONZE | SILVER CLAD | CE/2014/11747; CANEC1401599601 |
| 12 | TERMINAL | 2 | BRASS | SILVER PLATING | CE/2014/11738; CANEC1401599601 |

| DATE | APPROVAL | DESIGN | ENGINEERING CHANGE DESCRIPTION | DESIGN | ZHU | VER. | 01 | 3D FILE NAME | |
|------|----------|--------|--------------------------------|----------|------------|-------|-------|---------------|----------------------------|
| | | | | DATE | 2011/12/19 | UNIT | mm | MODE | PUSHBUTTON SWITCH WITH LED |
| | | | | APPROVAL | KAVEN | SCALE | 1 : 1 | PART | PS004-N22NPR2KTUGXX |
| | | | | CONFIRM | TEREANCE | VIEW | | 2D FILE NAME | PS004-N22NPR2KTUGXX |
| | | | | DESIGN | ZHU | VER. | 01 | MATERIAL LIST | |