

SPECIFICATIONS

规格承认书

DESCRIPTION (产品描述):

PART NO (品名/型号): **T10-WG-020W3528**

(A) Electronics And Optical Characteristics: Ta=25°C (光电指数 在室温 25°C):

Emitting Color (发光颜色)	Forward Voltage Unit: V (顺向电压)	Totality Luminous Intensity Unit:LM (整体发光强度)	Single LED Intensity Unit: LM (单颗 SMD 的亮度)	Dominant Wavelength Unit: nm (波长)	Viewing Angle Unit: deg (发光角度)	Color Temperature Unit: K (色温)
WHITE	12	50~55	5-7	--	360	6000~6500
Test Condition (测试条件)	Test Voltage (测试电压): 12VDC		Current (电流): 99mA		Power (功率): 1.2W	
IR max (反向电流): 0.01mA; VR (反向电压) =5V						

Package Dimensions(产品外观尺寸):

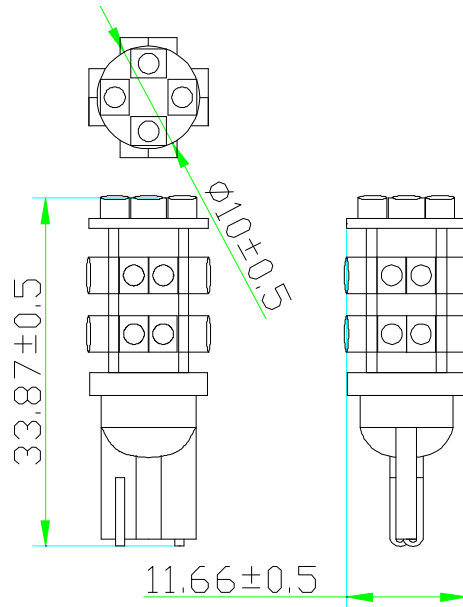

Unit (单位): MM

(B) Absolute Maximum Ratings AT Ta=25°C (标准最大值评定结果 在室温 25°C)

PARAMETER (参数)	MAX (最大值)	UNIT (单位)
Continuous Forward Current (持续顺向电流)	30	mA
Peak Forward Current (1/10 Duty Cycle 0.1ms Pulse Width) 脉冲电流 (工作循环 1/10 脉冲宽度 0.1ms)	150	mA
Reverse Voltage (反向电压)	5	V
Operating Temperature Range (工作温度)	-40°C to +85°C	
Storage Temperature Range (存储温度)	-40°C to +85°C	
Lead Solder Temperature Below Package 260°C For 5 seconds (管脚焊接温度在 5 秒内 260°C 以下焊接)		

承认规格书

SPECIFICATION FOR APPROVAL

CUSTOMER (客户): _____
DESCRIPTION (品名): T10-WG-020W3528
DIMENSIONS (规格): 12VDC
LENSCOLOR (发光颜色): WHITE
NO. (编号): _____

Approval 确认	Check 审核	Design 制作	Confirmed by 客户确认	
潘江	郑华坤	田勇		