

J	序号 SUITE	重点尺寸 Major Dimension	工具 TOOL
	△		卡尺
	△		投影机
	△		投影机
	△		投影机
	△		投影机
	△		卡尺
	△		投影机
	△		投影机
	△		卡尺

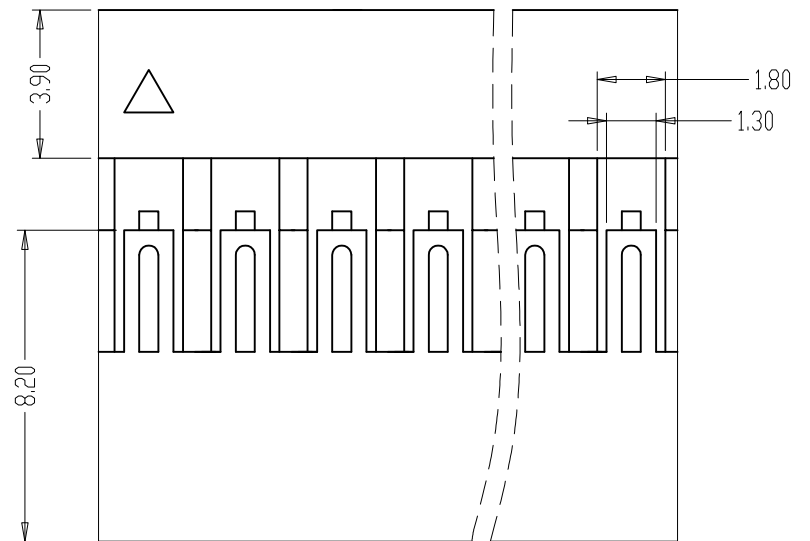
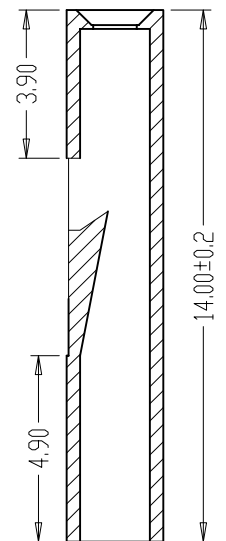
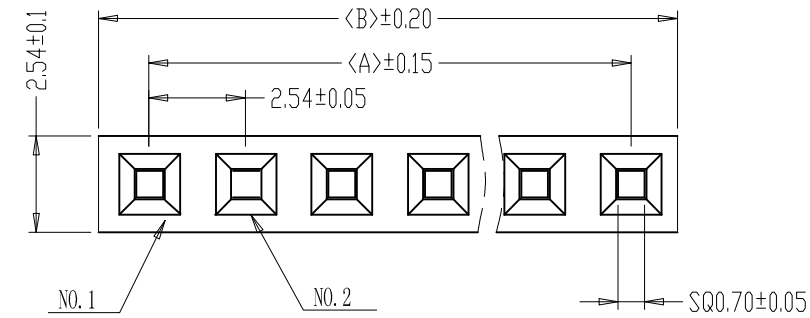

PART NO	Dimensions	
	A	B
ZL2543-Y-1x2P	2.54	5.08
ZL2543-Y-1x3P	5.08	7.62
ZL2543-Y-1x4P	7.62	10.16
ZL2543-Y-1x5P	10.16	12.70
ZL2543-Y-1x6P	12.70	15.24
ZL2543-Y-1x7P	15.24	17.78
ZL2543-Y-1x8P	17.78	20.32
ZL2543-Y-1x9P	20.32	22.86
ZL2543-Y-1x10P	22.86	25.40
ZL2543-Y-1x11P	25.40	27.94
ZL2543-Y-1x12P	27.94	30.48
ZL2543-Y-1x13P	30.48	33.02
ZL2543-Y-1x14P	33.02	35.56
ZL2543-Y-1x15P	35.56	38.10
ZL2543-Y-1x16P	38.10	40.64
ZL2543-Y-1x17P	40.64	43.18
ZL2543-Y-1x18P	43.18	45.72
ZL2543-Y-1x19P	45.72	48.26

- 说明:
- 1、产品料号: ZL2543-Y
  - 2、塑胶材质: PPO UL94V-0
  - 3、额定电压: 250V. AC/DC
  - 4、额定电流: 2.5A
  - 5、耐压值: 800AC/minute
  - 6、接触电阻: 10MΩ (MAX)
  - 7、绝缘电阻: 1000MΩ (MIN)
  - 8、使用温度: -25° C ~ +85° C

修改记录	图号	ZL2543-Y	绘图	康靖	材质	PPO	颜色	黑色	SIZE	M
	FILE NO.		审核		单位	mm	比例	1:1		
	品名	杜邦2.54单排孔座	核准		<h2 style="text-align: center;">ZL2543-5PS</h2>					
	TITLE		页数	1/1						
	料号	ZL2543-Y	SHEET							
版本	08/09/27	初版发行	角度	± 1°						
日期		变更内容	DIM	TOL						
版次		修改	核准							
REC	DATE	MODIFICATION DRAWN	DRAWN	APPROVED						

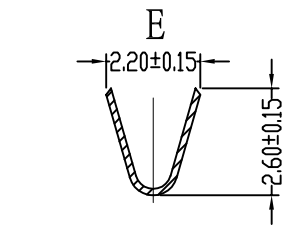
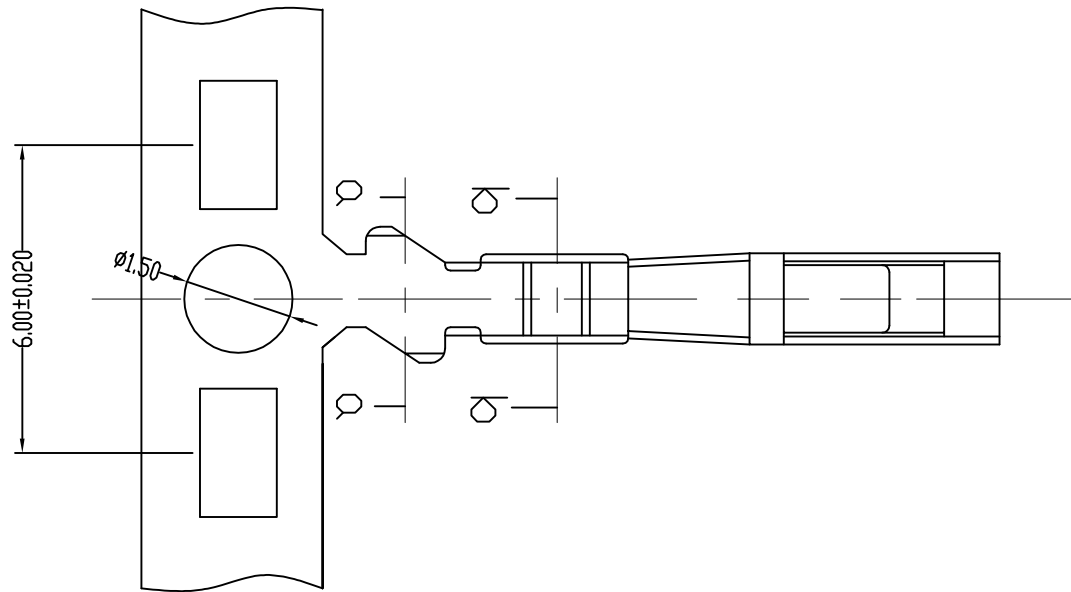

SECTION: a-a

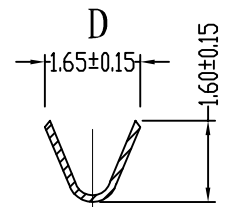

SECTION: b-b

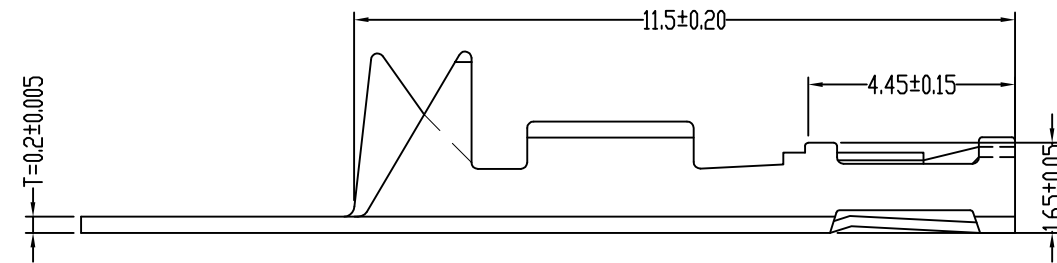

C

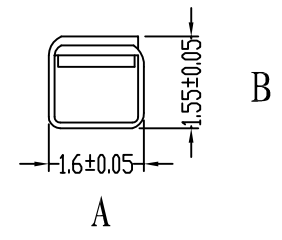

A

B

序号 SUITE	重点尺寸 Major Dimension	工具 TOOL
△		卡尺
△		投影机
△		投影机
△		投影机
△		投影机
△		卡尺
△		投影机
△		投影机
△		卡尺
△		卡尺

说明:

- 1、端子料号: ZL2543-T
- 2、端子材质: 磷青铜
- 3、适应基板厚度: 1.6mm
- 4、温度范围:  $-25^{\circ}\text{C} \sim +85^{\circ}\text{C}$
- 5、额定电压: 250V. AC/DC
- 6、额定电流: 2.5A
- 7、接触电阻:  $\leq 0.01\Omega$
- 8、绝缘电阻:  $\geq 1000\text{M}\Omega$
- 9、适用线规: AWG#22 ~ #28

修改记录	PA	08/9/27	初版发行			~ 3	$\pm 0.06$	图号	ZL2543-T	绘图	材质	磷青铜	颜色	SIZE	A4	
	版次	日期	变更内容	改变	核准	3 ~ 10	$\pm 0.10$	FILE NO.		DRAWN	单位	mm	比例	1:1		
	REC	DATE	MODIFICATION	DRAWN	APPROVED	10 ~ 20	$\pm 0.15$	TITLE	杜邦2.54端子	CHECKED			SCALE			
						20 ~ 30	$\pm 0.20$	料号	ZL2543-T	核准						
						30 ~	$\pm 0.30$	PART NO.		APPROVED						
						Angle	$\pm 1^{\circ}$	模具号	XXXX	页						
						DIM	TOL	MOLD NO.		数	1/1					
										SHEET						

ZL2543-5PS